

CINCINNATI®

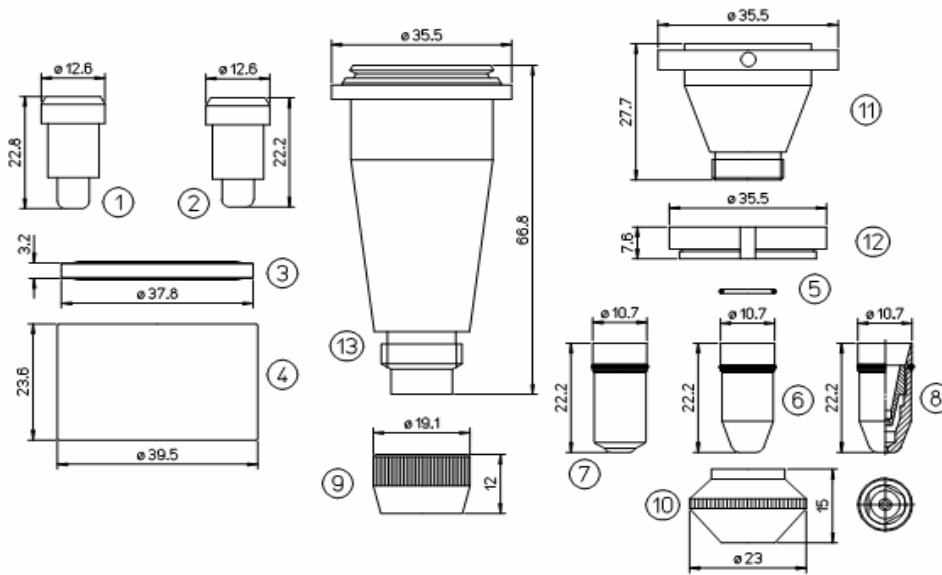

Picture #	Part Number	DESCRIPTION
1	908090	CINCINNATI® ELONGATED NOZZLE Ø 1.5
2	907469	CINCINNATI® NOZZLE Ø 1.0
	907470	CINCINNATI® NOZZLE Ø 1.5
	920006	CINCINNATI® NOZZLE Ø 2.0
3		CINCINNATI® GASKET TEFLON WITH SPRING
4	907677	CINCINNATI® NOZZLE HOLDER
	907472	CINCINNATI® NOZZLE HOLDER WITH GASKET
5	909680	CINCINNATI® O-RING FOR NOZZLE - 10PC
6	924635	CINCINNATI® NOZZLE Ø 1.0 W/O RING
		CINCINNATI® NOZZLE Ø 1.2 W/O RING
		CINCINNATI® NOZZLE Ø 1.3 W/O RING
		CINCINNATI® NOZZLE Ø 1.4 W/O RING
	909660	CINCINNATI® NOZZLE Ø 1.5 W/O RING
	910315	CINCINNATI® NOZZLE Ø 2.0 W/O RING
	924638	CINCINNATI® NOZZLE Ø 2.5 W/O RING
	924634	CINCINNATI® NOZZLE Ø 3.0 W/O RING
7	923013	CINCINNATI® SHOWER NOZZLE Ø 1.0 W/O RING
	923014	CINCINNATI® SHOWER NOZZLE Ø 1.5 W/O RING
		CINCINNATI® SHOWER NOZZLE Ø 2.0 W/O RING
7	924636	CINCINNATI® NOZZLE Ø 1.5 W/O RING
	924637	CINCINNATI® NOZZLE Ø 2.0 W/O RING
8	ESSE A. DESIGN	CINCINNATI® DOUBLE NOZZLE Ø 1.0 W/O RING
	ESSE A. DESIGN	CINCINNATI® DOUBLE NOZZLE Ø 1.5 W/O RING
	ESSE A. DESIGN	CINCINNATI® DOUBLE NOZZLE Ø 2.0 W/O RING
9	909659	CINCINNATI® TIP LOCK NUT
10	963021	CINCINNATI® TIP RETAINER NUT

11		CINCINNATI® TIP RETAINER
12		CINCINNATI® INSULATOR RING
13	909658	CINCINNATI® TIP RETAINER EXTENTION